

- Page 1
Section
Dimensions
Car data
- Page 2
Width
dimensions
- Page 3
Width
dimensions
Approach
Free spaces
- Page 4
Function
Load plan
- Page 5
Electric data
Techn. data
To be performed
by the customer
- Page 6
Description

Standard Type 4300

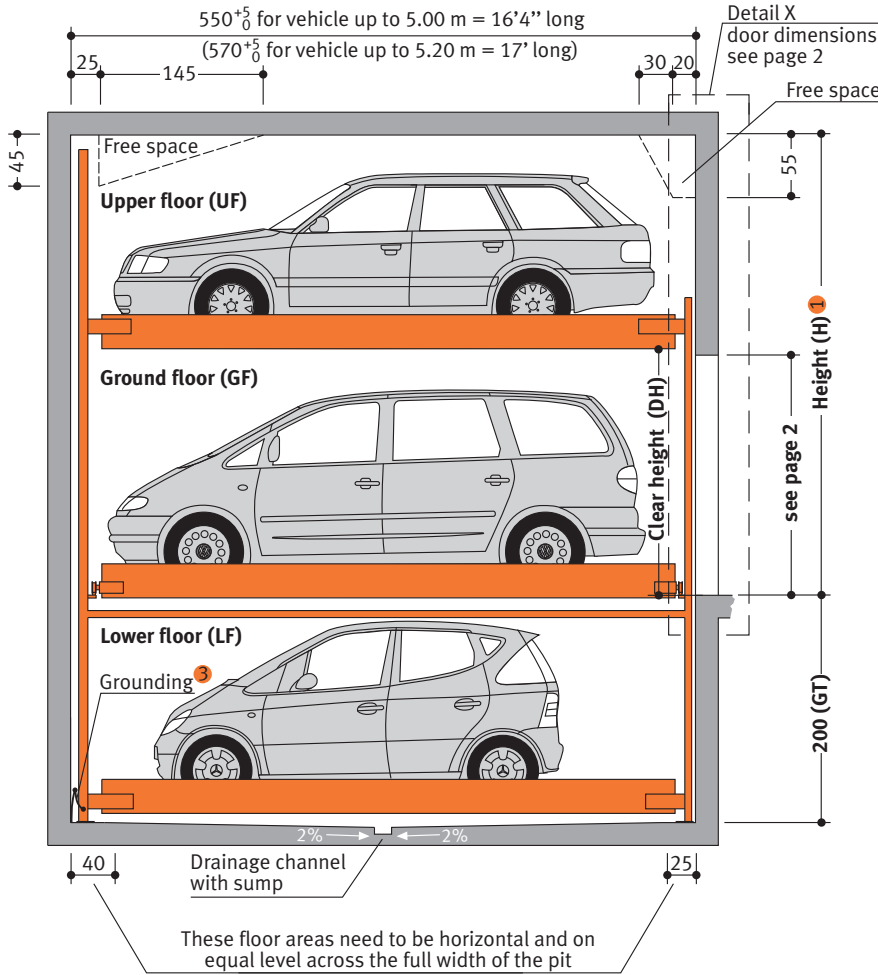

Product Data TrendVario 4300



Loadable up to 2,600 kg
Single parking spaces can also be upgraded to handle heavier loads at a later date!

Number of parking spaces:
min. 5 to max. 29 vehicles

Dimensions: ②
All space requirements are minimum finished dimensions. Tolerances for space requirements ⁺³/₀. Dimensions in cm.

Type	GT	H	DH*
4300	175	345	175
4300	175	365	195
4300	175	380	210
4300	200	375	180
4300	200	405	210
4300	230	435	210

* = without car

Suitable for:
Standard passenger car, station wagon/
Van. Height and length according
to contour.

Type	GT	H	car height		
			UF	GF	LF
4300	175	345	150	170	150
4300	175	365	150	190	150
4300	175	380	150	205	150
4300	200	375	175	175	175
4300	200	405	175	205	175
4300	230	435	205	205	205

width	190 cm
weight ④	max. 2000/2600 kg
wheel load	max. 500/650 kg

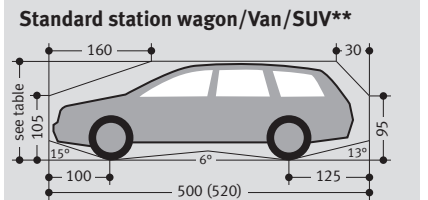
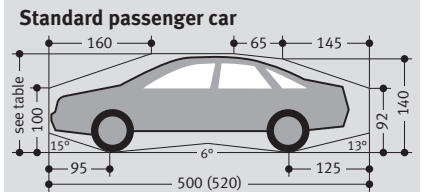

Standard passenger car, station wagon/
Van/ SUV are vehicles without any sports
options such as spoilers, low-profile tyres etc.
** = Make sure to observe the weights and dimensions!

Compact Type 4300

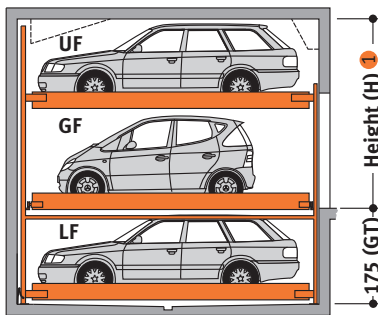

Exclusive Type 4300

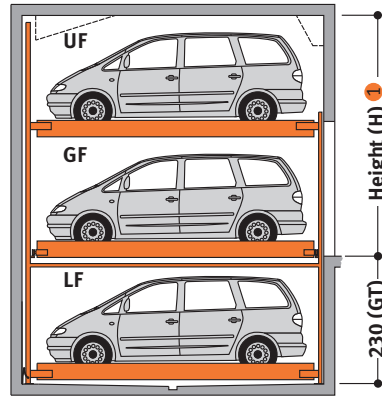

Notes

- ① If height H is larger, vehicles with the maximum height as applicable for the GF can be parked on the UF, otherwise there will be free space available on the ceiling.
- ② In order to meet the minimum finished dimensions the tolerances according to VOB, part C (DIN 18330 and 18331) as well as the DIN 18202 must be observed.
- ③ Potential equalization from foundation grounding connection to system (provided by the customer).
- ④ Maximum load of 2,600 kg for extra charge.

General notes

If sprinklers are required make sure to provide the necessary free spaces during the planning stage.



Klaus Multiparking GmbH
Hermann-Krum-Straße 2
D-88319 Aitrach
Phone +49-75 65-5 08-0
Fax +49-75 65-5 08-88
E-Mail info@multiparking.com
Internet www.multiparking.com

Page 1
Section
Dimensions
Car data

Page 2
Width
dimensions

Page 3
Width
dimensions
Approach
Free spaces

Page 4
Function
Load plan

Page 5
Electric data
Techn. data
To be performed
by the
customer

Page 6
Description

Widths – Detail X for garages with sliding doors (Standard)

Sliding door behind columns

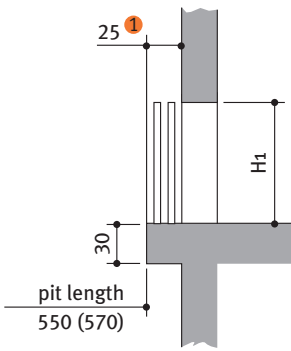

Type	GT	H	DH	H1
4300	175	345	175	210
4300	175	365	195	210
4300	175	380	210	220
4300	200	375	180	210
4300	200	405	210	220
4300	230	435	210	220

Sliding door between columns

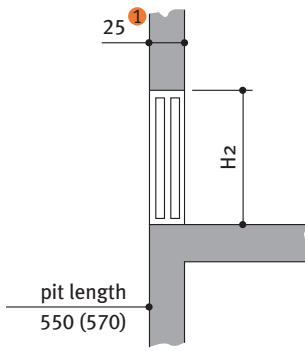

Type	GT	H	DH	H2
4300	175	345	175	220
4300	175	365	195	220
4300	175	380	210	230
4300	200	375	180	220
4300	200	405	210	230
4300	230	435	210	230

Sliding door in front of columns

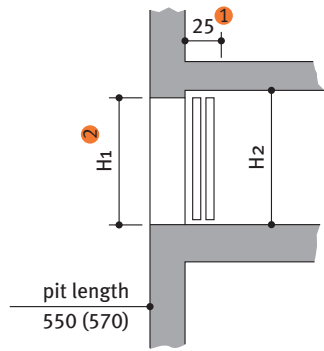

Type	GT	H	DH	H1	H2
4300	175	345	175	210	220
4300	175	365	195	210	220
4300	175	380	210	210	230
4300	200	375	180	210	220
4300	200	405	210	220	230
4300	230	435	210	220	230

Columns per each grid unit

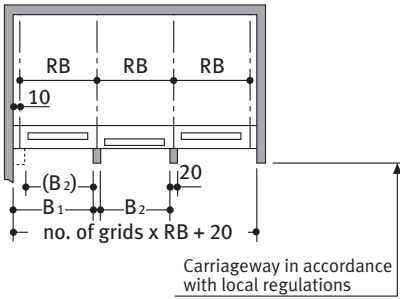

usable platform width	grid unit width RB**	B1	B2
230*	250	250	230
240	260	260	240
250	270	270	250
260	280	280	260
270	290	290	270

Columns per each grid unit

Not available!

Columns per each grid unit

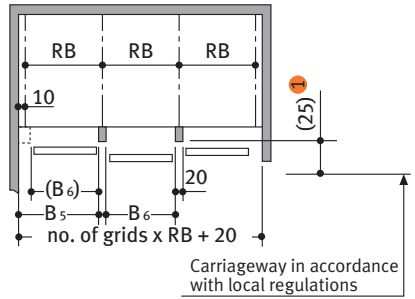

usable platform width	grid unit width RB**	B5	B6
230*	250	250	230
240	260	260	240
250	270	270	250
260	280	280	260
270	290	290	270

Columns every second grid unit

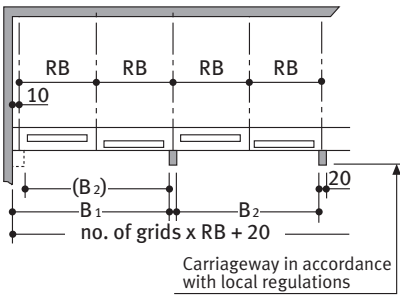

usable platform width	grid unit width RB**	B1	B2
230*	250	500	480
240	260	520	500
250	270	540	520
260	280	560	540
270	290	580	560

Columns every second grid unit

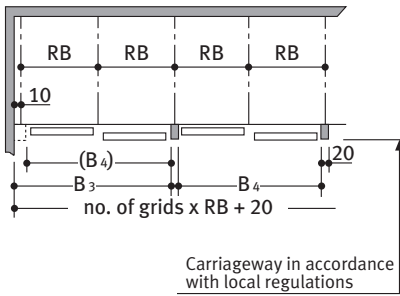

usable platform width	grid unit width RB**	B3	B4
230*	250	500	480
240	260	520	500
250	270	540	520
260	280	560	540
270	290	580	560

Columns every second grid unit

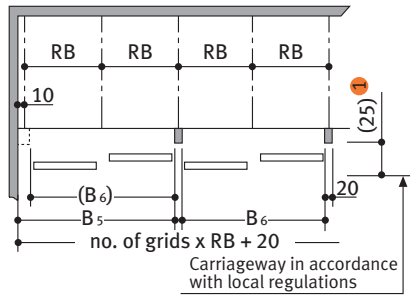

usable platform width	grid unit width RB**	B5	B6
230*	250	500	480
240	260	520	500
250	270	540	520
260	280	560	540
270	290	580	560

① = Only applies to manually operated doors.
The electrically driven doors must have 35 cm.

* = Standard width (parking space width 230 cm)

** = Grid unit width **must** strictly conform to dimensions quoted

! End parking spaces are generally more difficult to drive into. Therefore we recommended for end parking spaces our wider platforms. Parking on standard width platforms with larger vehicles may make getting into and out of the vehicle difficult. This depends on type of vehicle, approach and above all on the individual driver's skill.

- Page 1
Section
Dimensions
Car data
- Page 2
Width
dimensions
- Page 3
Width
dimensions
Approach
Free spaces
- Page 4
Function
Load plan
- Page 5
Electric data
Techn. data
To be performed by the
customer
- Page 6
Description

Widths – Detail X for garages with roll doors

Roll door behind columns

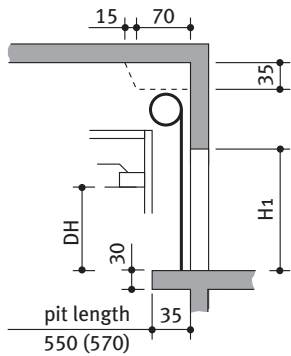

Columns per each grid unit

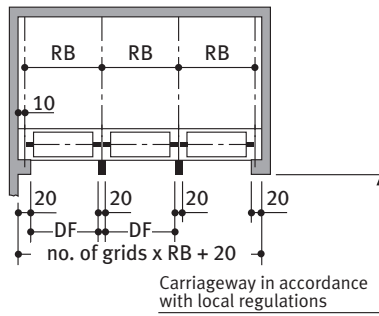

Type	GT	H	DH	H ₁	roll door height
4300	175	345	175	210	263
4300	175	365	195	210	263
4300	175	380	210	220	300
4300	200	375	180	210	263
4300	200	405	210	220	300
4300	230	435	210	220	300

usable platform width	grid unit width RB**	door entrance width DF
230 *	250	230
240	260	240
250	270	250
260	280	260
270	290	270

* = Standard width (parking space width 230 cm)

** = Grid unit width **must** strictly conform to dimensions quoted

! End parking spaces are generally more difficult to drive into. Therefore we recommended for end parking spaces our wider platforms. Parking on standard width platforms with larger vehicles may make getting into and out of the vehicle difficult. This depends on type of vehicle, approach and above all on the individual driver's skill.

Approach

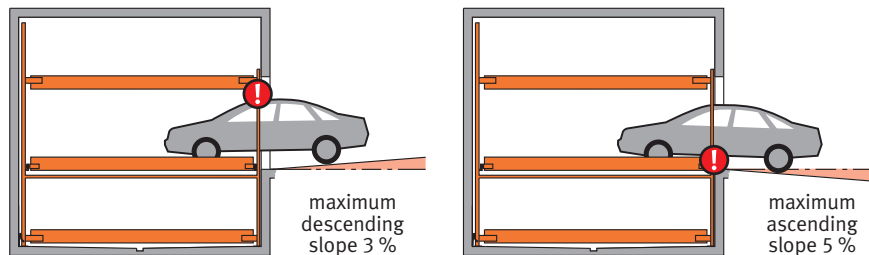

! The illustrated maximum approach angles must not be exceeded. Incorrect approach angles will cause serious manoeuvring & positioning problems on the parking system for which the local agency of Klaus accepts no responsibility.

Longitudinal free space; Standard parking space numbers; Denomination

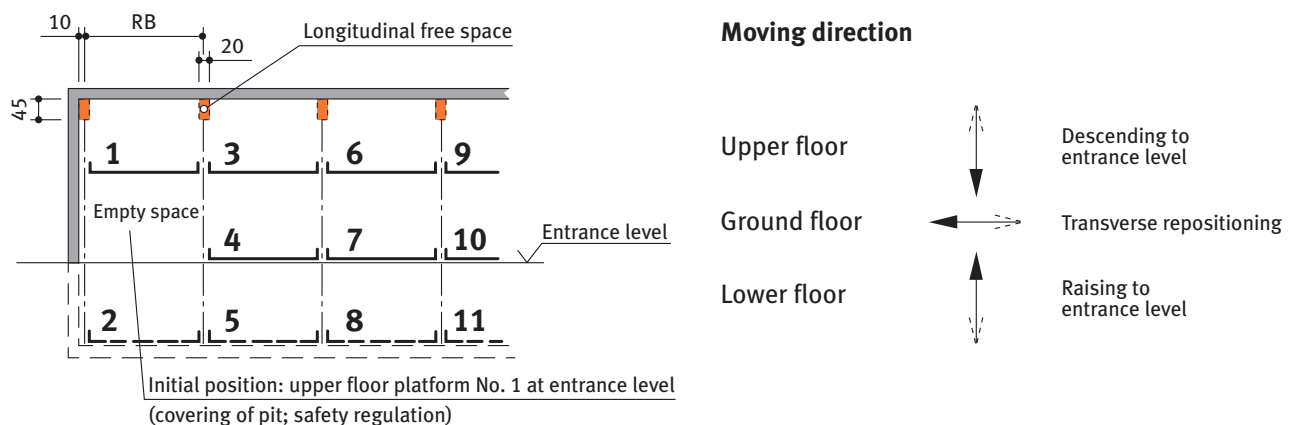

Page 1
Section
Dimensions
Car data

Page 2
Width
Dimensions

Page 3
Width
Dimensions
Approach
Free spaces

Page 4
Function
Load plan

Page 5
Electric data
Techn. data
To be performed
by the customer

Page 6
Description

Function

e.g. for parking space No. 8:
Check first that all doors are closed, then select No. 8 on operating panel.

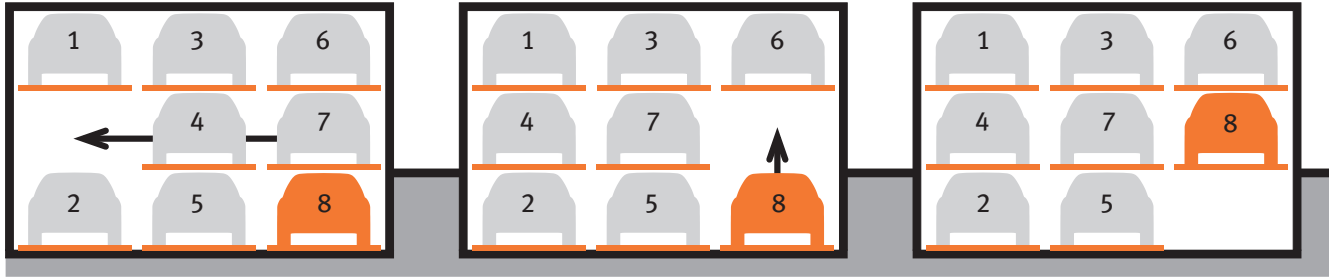

For driving the vehicle off platform No. 8 the ground floor parking platforms are shifted to the left.

The empty space is now below the vehicle which shall be driven off the platform. The platform No. 8 will be lowered.

The vehicle on platform No. 8 can now be driven off the platform.

Load plan

Compact Type

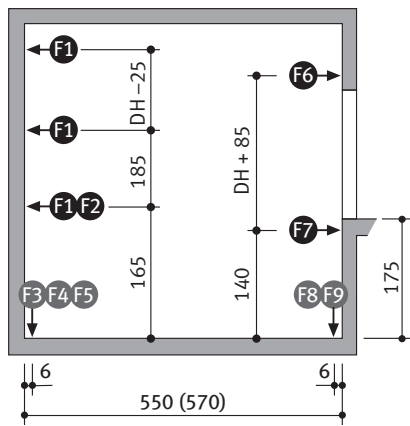

Standard Type

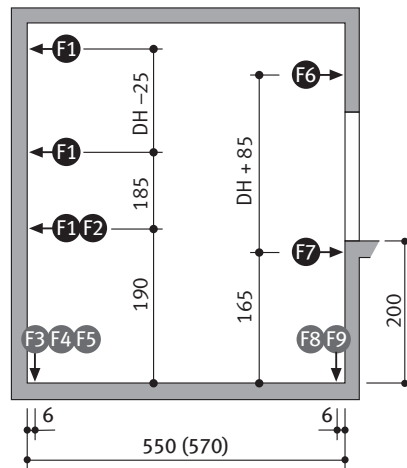

Exclusive Type

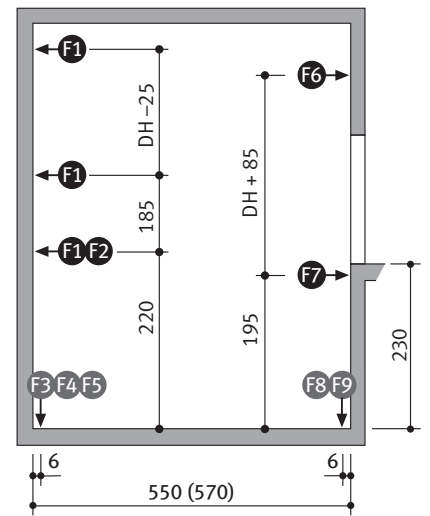

DH: see page 1

The dimensions for the points of support are rounded values. If the exact position is required, please contact Klaus Multiparking.

Load plan – top view

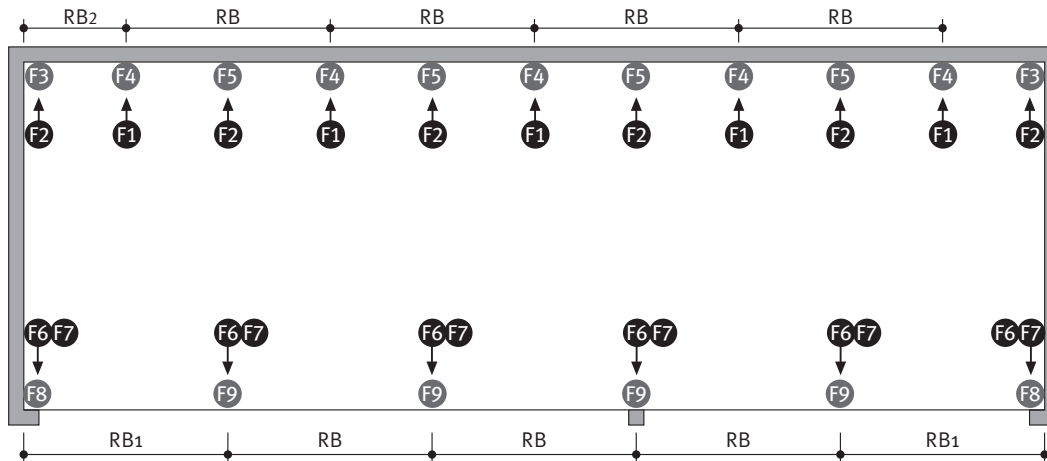

usable platform width	RB	RB1	RB2
230*	250	260	135
240	260	270	140
250	270	280	145
260	280	290	150
270	290	300	155

platform load	F1	F2	F3	F4	F5	F6	F7	F8	F9
2000 kg	±5	±2,5	±14,5	+70	±29	±0,2	±2,5	+25	+50
2600 kg	±5	±2,5	±14,5	+80	±29	±0,2	±2,5	+35	+70

Forces in kN

! The system is dowelled to floor and walls. The drilling depth in the floor is approx. 15 cm. The drilling depth in the walls is approx. 12 cm. Floor and walls are to be made of concrete (grade of concrete min. C20/25)!

Page 1
Section
Dimensions
Car data

Page 2
Width
Dimensions

Page 3
Width
Dimensions
Approach
Free spaces

Page 4
Function
Load plan

Page 5
Electric data
Techn. data
To be performed
by the customer

Page 6
Description

Electrical data

Control box

The control box must be accessible at all times from outside!

Dimensions approx. 100 x 100 x 30 cm.

Cutting through of wall from control box to parking system (contact the local agency of Klaus Multiparking for clarification)

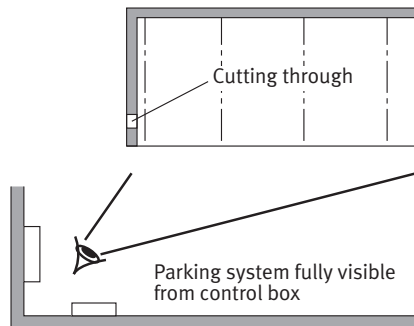

Technical data

Range of application

Generally, this parking system is not suited for short-time parkers (temporary parkers). Please do not hesitate to contact your local KLAUS agency for further assistance.

Available documents

- wall recess plans
- maintenance offer/contract
- declaration of conformity
- test sheet on airborne and slid-borne sound

Corrosion protection

See separate sheet regarding corrosion protection.

Environmental conditions

Environmental conditions for the area of multiparking systems: Temperature range –10 to +40° C. Relative humidity 50 % at a maximum outside temperature of +40° C.

If lifting or lowering times are specified, they refer to an environmental temperature of +10° C and with the system set up directly next to the hydraulic unit. At lower temperatures or with longer hydraulic lines, these times increase.

Electrically driven doors

In accordance with ZH 1/494 commercially used power-driven doors must be subjected to annual inspections. We urgently recommend concluding a maintenance agreement that includes this service for the entire system.

Numbering

The standard numbering of the parking spaces is to be taken from page 3. Different numbering is only possible at extra cost. Please take note of the following specifications:

In general, the empty space must be arranged to the left. The numbers must be provided 8 – 10 weeks before the delivery date.

To be performed by the customer

Safety fences

Any constraints that may be necessary according to DIN EN ISO 13857 in order to provide protection for the park pits for pathways directly in front, next to or behind the unit. This is also valid during construction.

Numbering of parking spaces

Consecutive numbering of parking spaces.

Building services

Lighting, ventilation, fire extinguishing and fire alarm systems.

Drainage

For the middle area of the pit we recommend a drainage channel, which you connect to a floor drain system or sump (50 x 50 x 20 cm). The drainage channel may be inclined to the side, however not the pit floor itself (longitudinal incline is available). In the interests of environmental protection we recommend painting the pit floor. Oil and petrol separators must be provided according to the statutory provisions when connecting to the public sewage system!

Wall cuttings

Any necessary wall cuttings.

Electrical supply to the control box / Foundation earth connector

Suitable electrical supply 5 x 2.5 mm² (3 PH+N+PE) to control box with mains fuse 3 x 16 A slow or over-current cut-out 3 x 16 A trigger characteristic K or C.

Suitable electrical supply to the control box must be provided by the customer during installation. The functionality can be monitored on site by our fitters together with the electrician. If this cannot be done during installation for some reason for which the customer is responsible, the customer must commission an electrician at their own expense and risk.

In accordance with DIN EN 60204 (Safety of Machinery. Electrical Equipment), grounding of the steel structure is necessary, provided by the customer (distance between grounding max. 10 m).

Operating device

Easy-to-survey positioning (e.g. on column).

Protection against unauthorized use.

May also be recessed in wall if required.

Sound insulation

According to DIN 4109 (Sound insulation in buildings), para. 4, annotation 4, Klaus Multiparkers are part of the building services (garage systems).

Normal sound insulation:

DIN 4109, para. 4, Sound insulation against noises from building services.

Table 4 in para. 4.1 contains the permissible sound level values emitted from building services for personal living and working areas. According to line 2 the maximum sound level in personal living and working areas must not exceed 30 dB (A).

Noises created by users are not subject to the requirements (see table 4, DIN 4109).

The following measures are to be taken to comply with this value:

- Sound protection package according to offer/order (Klaus Multiparking GmbH)
- Minimum sound insulation of building $R'_w = 57$ dB (to be provided by customer)

Increased sound insulation (special agreement):

DIN 4109, Amendment 2, Information on planning and execution, proposals for increased sound insulation.

Agreement: Maximum sound level in personal living and working areas 25 dB (A). *Noises created by users are not subject to the requirements (see table 4, DIN 4109).*

The following measures are to be taken to comply with this value:

- Sound protection package according to offer/order (Klaus Multiparking GmbH)
- Minimum sound insulation of building $R'_w = 62$ dB (to be provided by customer)

Note: User noises are noises created by individual users in our Multiparking systems. These can be noises from accessing the platforms, slamming of vehicle doors, motor and brake noises.

Strip footings

If due to structural conditions strip footings must be effected, the customer shall provide an accessible platform reaching to the top of the said strip footings to enable and facilitate themounting work.

Electrical supply to the control box / Foundation earth connector

Suitable electrical supply to the control box must be provided by the customer during installation. The functionality can be monitored on site by our fitters together with the electrician. If this cannot be done during installation for some reason for which the customer is responsible, the customer must commission an electrician at their own expense and risk.

In accordance with DIN EN 60204 (Safety of Machinery. Electrical Equipment), grounding of the steel structure is necessary, provided by the customer (distance between grounding max. 10 m).

Door shields

Door shields that may be necessary. If desired, they can be ordered from Klaus Multiparking for an additional charge.

If the following are not included in the quotation, they will also have to be provided / paid for by the customer:

- Costs for final technical approval by an authorized body

Page 1 Section Dimensions Car data
Page 2 Width dimensions
Page 3 Width dimensions Approach Free spaces
Page 4 Function Load plan
Page 5 Electric data Techn. data To be performed by the customer
Page 6 Description

Description

General description

Multiparking system providing independent parking spaces for cars, one on top of the other and side by side.

Dimensions are in accordance with the underlying dimensions of parking pit, height and width

The parking bays are accessed horizontally (installation deviation $\pm 1\%$).

Along the complete width of the parking automat an approach lane (driving lane in accordance with local regulations) must be available.

Parking spaces are arranged on three different levels, one level on top of the other

The platforms of both the lower floor (LF) and upper floor (UF) are moved vertically, the platforms of the ground floor (GF) horizontally. At approach level (GF) there is always one parking space less available. This vacant space is used for shifting the ground floor (GF) parking spaces sideways, thus enabling an upper floor (UF) parking space or lower floor (LF) parking space to be lowered or lifted to approach level. Consequently, a unit of five parking spaces (2 on the upper floor, 1 on the ground floor, 2 on the lower floor) is the smallest unit available for this parking system.

The TrendVario 4300 allows parking of passenger cars and station wagons.

For safety reasons the platforms can only be moved behind electromagnetically locked doors.

All necessary safety devices are installed. This consists mainly of a chain monitoring system, locking lever for the upper and lower platforms and electromagnetic door locks.

The doors can only be opened if the selected parking space has reached the park position and all openings are secured.

A steel framework mounted inside the pit, consisting of

- Seriated supports
- Steel pillars with sliding platform supports
- Cross and longitudinal members
- running rails for the transversely movable ground floor (GF) platforms

Platforms consisting of:

- Side members
- Cross members
- Platform base sections
- 1 wheel stop (on the right per parking space)
- Screws, small parts, etc.

Lifting device for upper floor (UF) and lower floor (LF) platforms:

- Hydraulic cylinder with solenoid valve
- Chain wheels
- Chains
- Limit switches
- The platforms are suspended on four points and guided along the supports using plastic sliding bearings.

Drive unit of transversely movable platforms on the ground floor (GF):

- Gear motor with chain wheel
- Chains
- Running and guide rollers (low-noise)
- Power supply via cable chain

Hydraulic unit consisting of:

- Hydraulic power unit (low-noise, installed onto a console with a rubber-bonded-to-metal mounting)
- Hydraulic oil reservoir
- Oil filling
- Internal geared wheel pump
- Pump holder
- Clutch
- 3-phase-AC-motor (3.0 kW, 230/400 V, 50 Hz)
- Motor circuit breaker
- Test manometer
- Pressure relief valve
- Hydraulic hoses (which reduce noise transmission onto the hydraulic pipe)

Control system:

- Central control panel (operating device) used to select the desired parking space
- With series installation, the doors are opened manually. If desired, this can also be done using electric motors
- Electric wiring is made from the electric cabinet by the manufacturer

Laterally movable doors

Size

Sliding door, dimensions: approx. 2500 mm x 2000 mm (width x height).

Frame

- Frame construction with vertical centre stay bar made from extruded aluminium profiles (anodized, layer thickness approx. 20 μm)
- To open the doors a recessed grip is integrated in the aluminium profile.
- A rubber lip is used for the finishing of the closing edge to the building.

Standard door panel

Perforated steel plate

- Thickness 1 mm, RV 5/8, galvanized, layer thickness: approx. 20 μm
- Ventilation cross-section of the panel approx. 40%
- Not suitable for outdoor garages

Alternative door panel

Perforated aluminium plate

- Thickness 2 mm, RV 5/8 E6/EV1, anodized, layer thickness: approx. 20 μm
- Ventilation cross-section of the panel approx. 40%

Beaded steel plate

- Thickness 1 mm, galvanized, layer thickness: approx. 20 μm .
- additional power coating, layer thickness: approx. 25 μm on the outside and approx. 12 μm on the inside
- Colour options for the outside (building view):
RAL 1015 (light ivory), RAL 3003 (ruby),
RAL 5014 (pigeon blue), RAL 6005 (moss green),
RAL 7016 (charcoal grey), RAL 7035 (light grey),
RAL 7040 (window grey), RAL 8014 (sepia),
RAL 9006 (white aluminium), RAL 9016 (traffic white)
- Inside of the gates in light grey

Plain aluminium sheet

- Thickness 2 mm, E6/EV1, anodized, layer thickness: approx. 20 μm

Wooden panelling

- Nordic spruce in grade A
- vertical tongue and groove boards
- preimpregnated colourless

Laminated safety glass

- Laminated safety glass made from single pane safety glass 8/4 mm

Running rails

- The running gear of each doors consists of 2 twin-pair rolling gadgets, adjustable in height
- The running rails of the doors are fixed to brackets or the concrete lintel, or on a building-specific door suspension using ceiling fittings
- The guide consists of 2 plastic rollers mounted to a base plate, which is dowelled to the floor
- Running rails, ceiling fittings and guide roller base plate are hot-dip galvanized

Door actuation

Standard:

- Manually, i.e. the door is opened and closed by hand

Alternatively:

- Electric drive via electric motor mounted to the rail system at the turning point of the sliding doors. The drive pinion engages into the chain mounted to the door.

For safety reasons the movement of the platforms is always made behind locked doors. Position sensing, i.e. "door open" and "door closed" is effected by electric signalers.

Separation (if necessary):

- Upon request

Please note:

Door panels (on the side, cover for running rails, etc.) and door suspensions are not included in the standard version but can be delivered against surcharge as special equipment.

We reserve the right to change this specification without further notice

The Klaus company reserves the right in the course of technical progress to use newer or other technologies, systems, processes, procedures or standards in the fulfillment of their obligations other than those originally offered provided the customer derives no disadvantage from their so doing.